

THESE DOCUMENTS ARE THE PROPERTY OF COUNTRY LANE WOODWORKING, LLC., PROVIDED BY RINEER DESIGNS. REPRODUCTION, ALTERATION OR USE OF THIS DRAWING WITHOUT WRITTEN CONSENT OF COUNTRY LANE WOODWORKING, LLC. IS PROHIBITED. DRAWINGS SHALL NOT BE SCALED TO OBTAIN DIMENSIONS. THE CONTRACTORS AND BUILDERS INVOLVED ON THIS PROJECT SHALL VERIFY ALL DIMENSIONS AND CONDITIONS BEFORE STARTING WORK. ANY DISCREPANCIES SHALL BE REPORTED TO COUNTRY LANE WOODWORKING, LLC. BEFORE STARTING WORK.

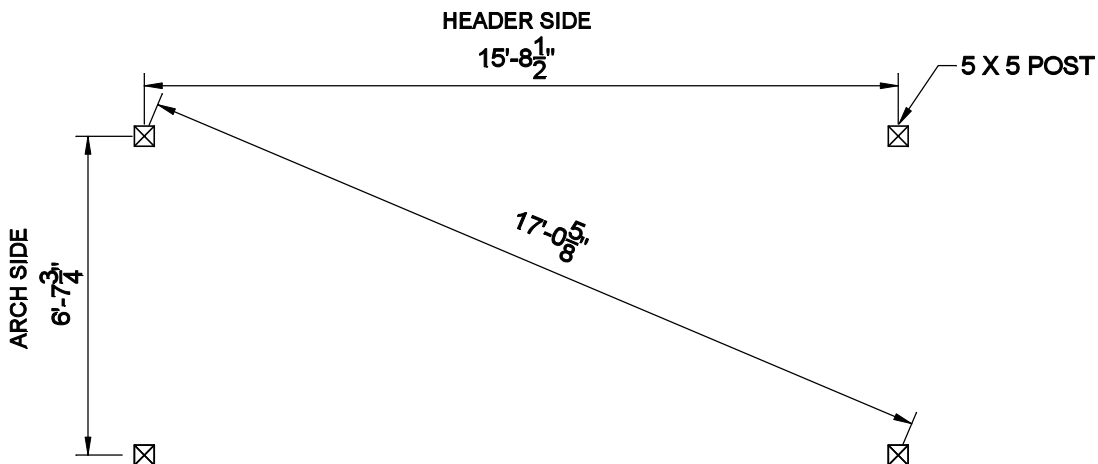

8' X 17' POST LAYOUT PLAN

SCALE: 1/4" = 1'-0"